

REVISIONS					
REV	ECN#	ZONE	DESCRIPTION	NAME	DATE
A	CP111989	PRODUCTION RELEASE PER CP111989	G. HARRINGTON	12/9/11

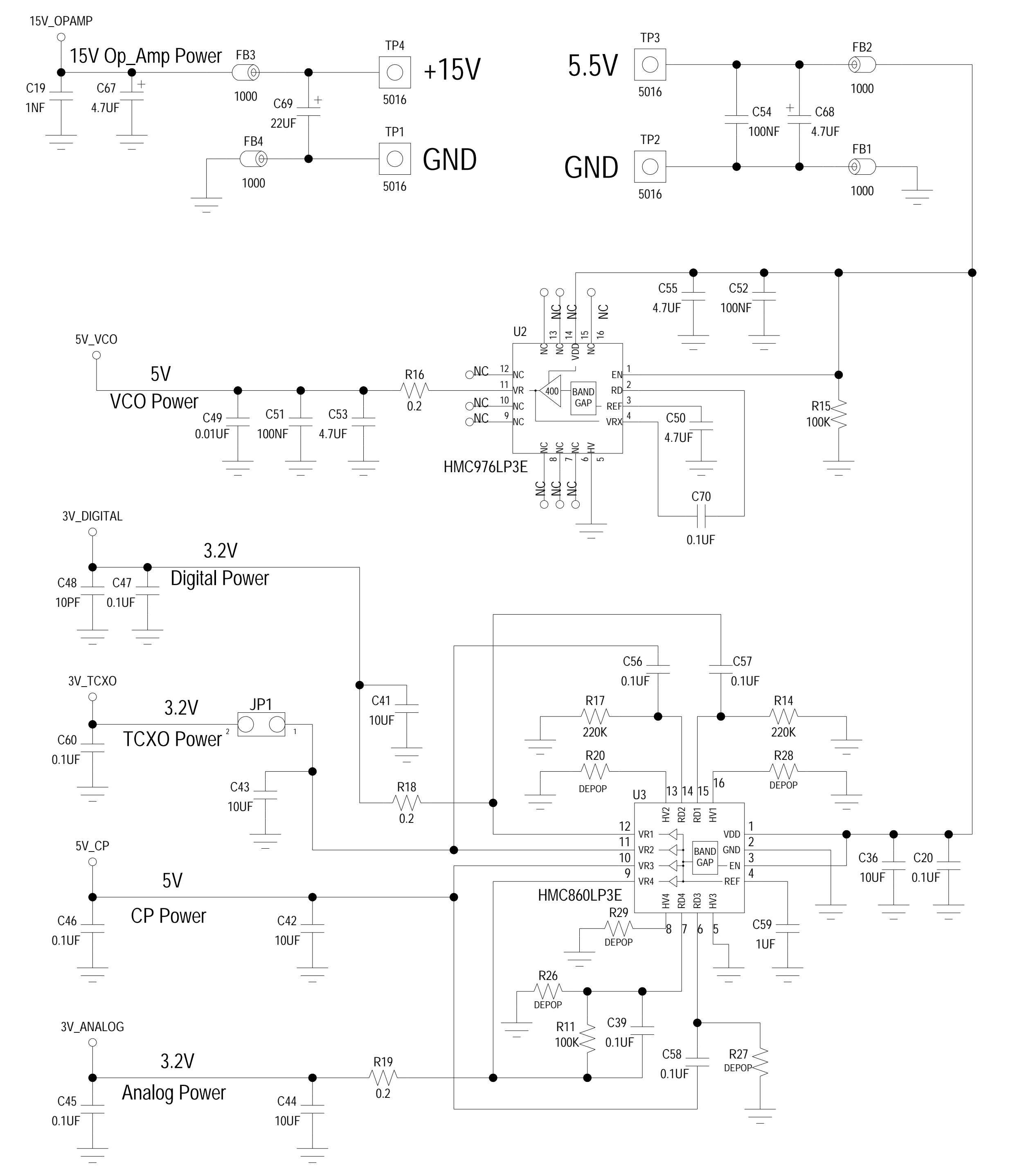
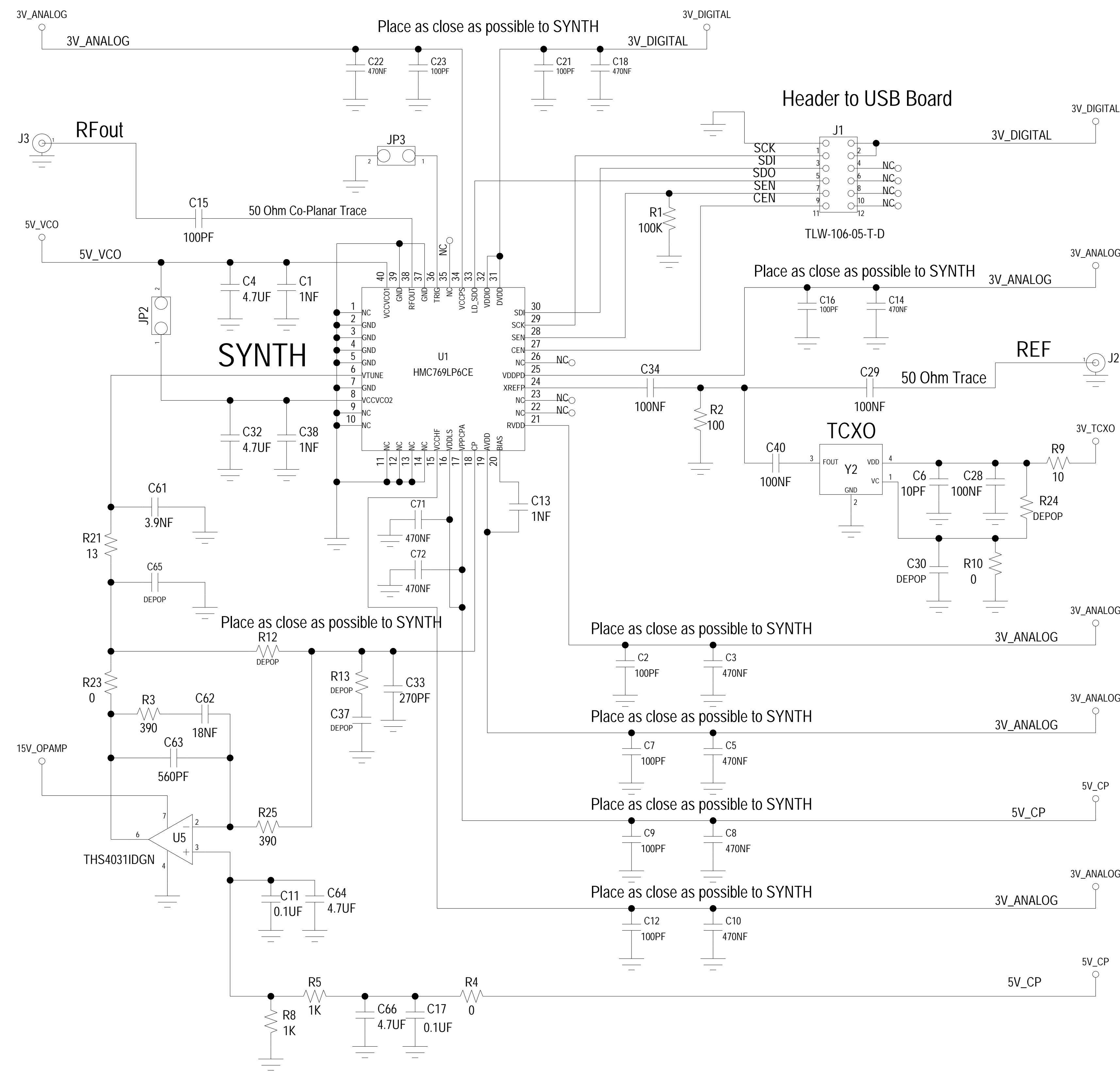

NOTICE OF PROPRIETARY PROPERTY: THIS DOCUMENT AND THE INFORMATION CONTAINED IN IT ARE THE PROPRIETARY PROPERTY OF HITTITE MICROWAVE CORPORATION. IT MAY NOT BE COPIED OR USED IN ANY MANNER NOR MAY ANY OF THE INFORMATION IN OR UPON IT BE USED FOR ANY PURPOSE WITHOUT THE EXPRESSED WRITTEN CONSENT OF AN AUTHORIZED AGENT OF HITTITE MICROWAVE CORPORATION.

HITTITE MICROWAVE CORPORATION
 20 Alpha Rd Chelmsford, MA 01824

TITLE SCH, EVAL FRACTIONAL N SYNTH W/WCO

PROJECT HMC769LP6CE

DRAWING #: 130722

DRAWN BY XG **DATE** 04/13/10

SHEET 1 **OF** 1

CODE ID NO. 1CN88 **SIZE** D **REV** A

09-12-2011_09:19